

# SOLAR HIGHWAY ANTI-GLARE SCREEN

Code: P-ADS-62S

No more accidents

## WHAT'S A SOLAR HIGHWAY ANTI-GLARE SCREEN?

This anti-glare device consists of modules with two boards designed for its installation over Jersey barriers that separate the traffic lanes in opposite directions on highways, freeways, and high-speed and slow lanes.

The separation and the angle of visibility between the boards are perfect for preventing glare with car lights in the opposite lane.

It includes a LED belt that preferably goes on curves (every five modules) to provide superb visibility of the curved line. This device is perfect for areas where there's rain or fog frequently.

Highway anti-glare screens are essential road safety devices for highways with concrete barriers in the middle.

2-year warranty against manufacturing and hidden defects.

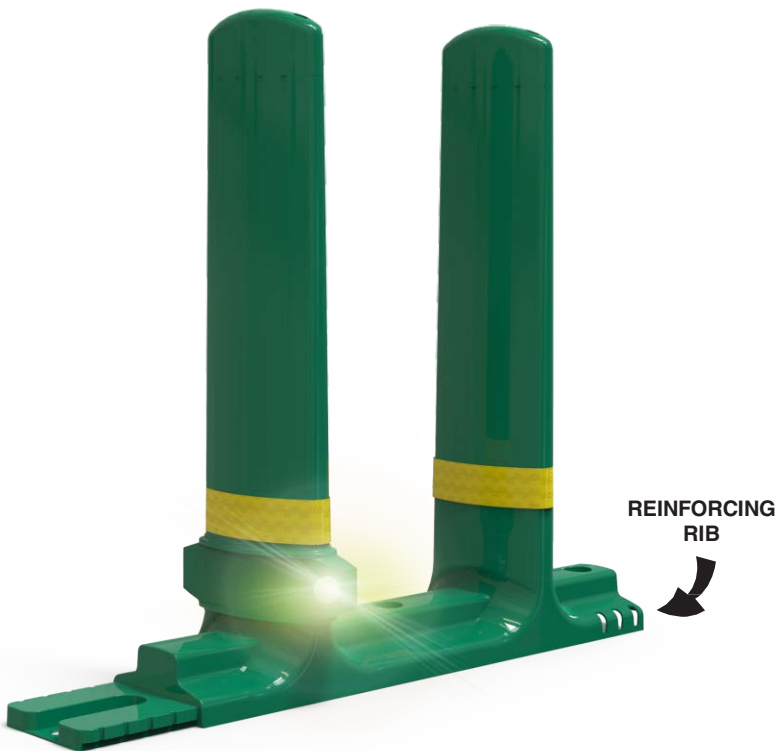

## Features

- Each screen has two anti-glare boards with round edges and a central reinforcing rib on the base.
- Made in one piece of high-impact resistant plastic.
- It has UV protection and resistance to weather conditions.
- It includes one amber reflective stripe on each board that guides the freeway and increases visibility.
- Easy to install with bolts or anchor bolts.

### SOLAR POWER SYSTEM THROUGH A "LED BELT".

- We recommend adding a LED belt for every five anti-glare screens but according to the circumstances we can increase or reduce the separation between them.
- Amber LED lights with optics that spread the light.
- For each LED belt, we use a 1.17 in. x 11.70 in. solar panel, two 1.5V batteries, and a JVM electronic system that syncs all the LED flashes of a curve simultaneously.
- It can run up to 24 hours with a flashing light on a single solar charge of 6 hours.



REFLECTIVE STRIPE

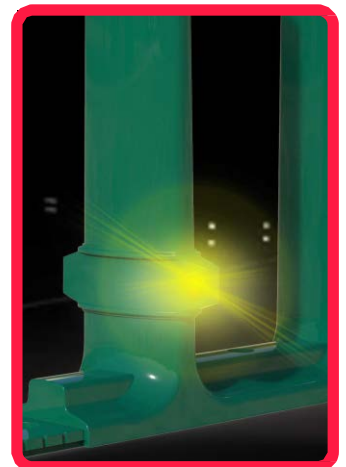

AMBER LED

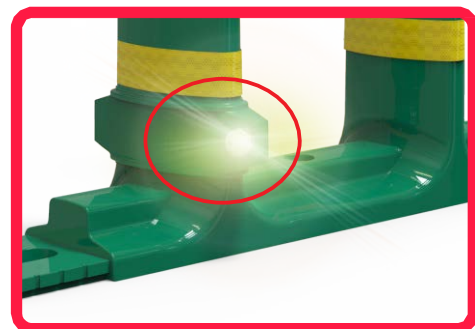

LED BELT

# SOLAR HIGHWAY ANTI-GLARE SCREEN

Code: P-ADS-62S

Volumes, dimensions, and other measures are nominal and may vary by approximately 2 %.

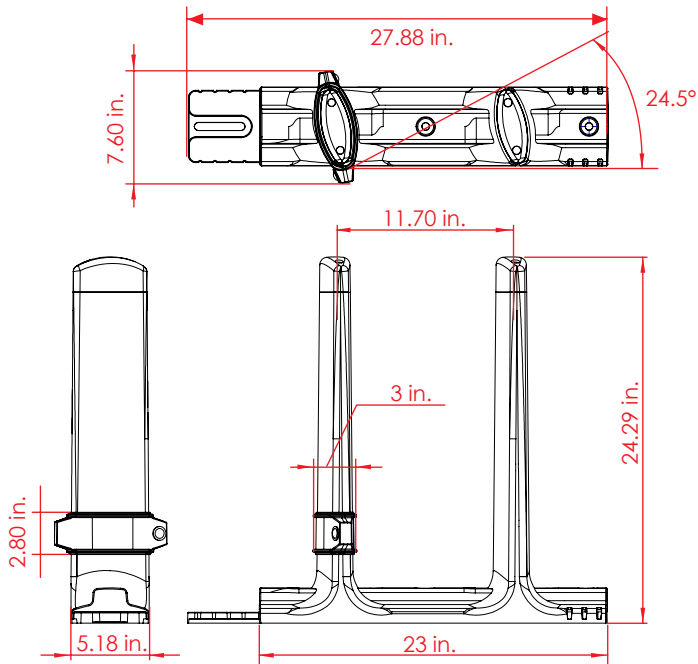

## Measures

<b>Total</b>	Total length: 27.88 in.
	Useful length: 23 in.
	Width: 7.60 in.
	Height: 24.29 in.
<b>Reflective:</b>	One stripe
<b>Reflective color:</b>	Amber

## Anchor system with an impact wrench

**Tools:** Tape measure, chalk, impact wrench, and a bolt with a ¼" socket wrench.

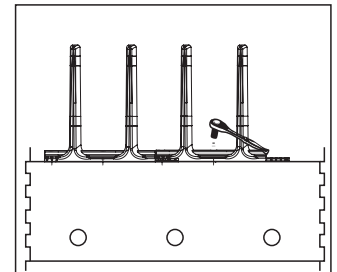
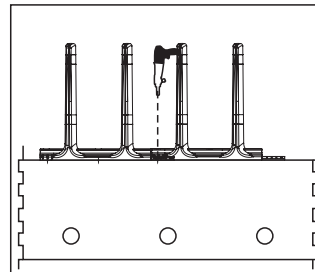

Place the Highway Anti-Glare Screen and use it as a template to hammer with the impact wrench the ¼" bolt on each of the three boreholes. Place its washer and nut.

Before you place the last nut, assemble the next Highway Anti-Glare Screen. And with the help of a ¼" socket wrench, fasten every nut of the previous screen. Make sure it locks securely. Continue the installation.

## Installation suggestion



### Bolt

- A ¼" bolt, nut, and washer.



### Anchor bolt

- An ¼" x 1 ¾" anchor bolt, nut, and washer.

## Anchor system with and anchor bolt

**Tools:** Tape measure, chalk, drill, anchor bolt, hammer, and a ¼" socket wrench.

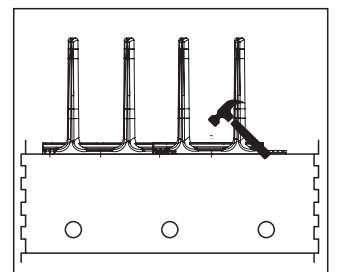
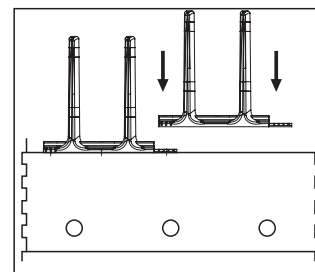

Mark the boreholes using the Highway Anti-glare Screen as a template. Drill with a ¼" drill bit to a depth of 2". Place the anchors. Perfectly hammer the anchor bolts.

Place the Highway Anti-glare Screen with its anchor bolt and washer and fasten it with the help of a ¼" socket wrench. Make sure it locks securely.

