

# Solar Arrow Board 610 / Cluster

Code: FS-610/CLUSTER



Posteflex  
Turtle Base



Tripod



Steel hooks

## Features

- Road signage devices essential in different transit and work situations.
- Work with solar energy, avoiding the need of other external power supplies.
- Reduce environmental impact and operational costs.
- Equipped with clusters of high intensity LED lighting, ensuring visibility in diverse light and climate conditions.
- Improve safety in roads thanks to high luminosity.
- Resist corrosive and saline environments, ideal for coastal and industrial areas.
- Durability in a great variety of adverse environments.
- Lightweight device allows easy transportation; can be placed by one person.
- Easy to install and move, depending on the project needs.
- These luminous arrow boards provide effective and adaptable solutions to different road and work signage needs, guaranteeing maximum safety and efficiency in any environment.

## 3 MOUNTING HOURS

- Mounted on 2"x2" Posteflex®, fixed to a turtle base type that can be filled with sand to avoid tipping.
- Steel hooks to mount on truck, always providing mobility and visibility.
- Mounting on tripod to be portable, and ease use in different locations.



# Solar Arrow Board 610 / Cluster

Code: FS-610/CLUSTER

## Features

- Made of HDPE in black color.
- Manufactured in a single piece, one face.
- Handle to ease the use and maneuverability.
- High resistance to temperature changes and adverse climate conditions, protection against UV rays ensuring durability and prevention of discoloration.
- Resistant to humidity, ideal to use in outdoors.
- 100% recyclable, developing environmental sustainability.
- It doesn't rust, maintaining its structural integrity over time.
- Design allow to stack several units, optimizing transport and storage costs.

## Mounting and Lighting

- **Lighting:** 9 acrylic clusters in amber or red color with light diffuser to optimize it.
- Photovoltaic panel of 650 mm x 92 mm x 16 mm of silicon of 10W, 6V, allowing an energy autonomy.
- Rechargeable battery of 3.4mA, guaranteeing between 10 and 16 hours of continuous functioning with a complete charge.
- This lightweight board of HDPE is designed to be robust, functional and sustainable that adapts to different signage and warning needs in outdoors.
- Made of plastic material, without resale value to dissuade thefts.



# Solar Arrow Board 610 / Cluster

Code: FS-610/CLUSTER

Measures in: in

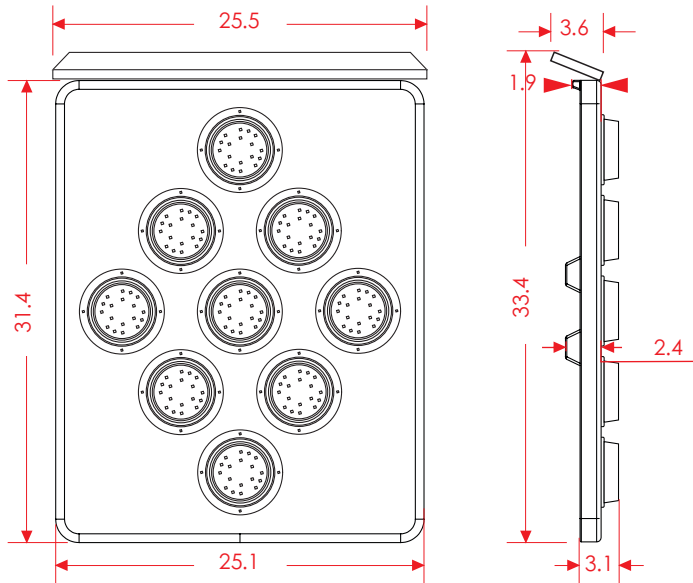

## Measurements

<b>General Measures:</b>	Length: 25.1 in
	Width: 2.4 in
	Height: 31.4 in
<b>Cluster Board:</b>	Length: 24.0 in
	Height: 29.9 in

## Lighting System

### Luminous Modules

09 LED clusters with LED holder, protective mica and butyl seal.

### PANEL SOLAR MONO -10W

- **Lighting Color:** Amber or red
- **Maximum Power (Pm):** 10W
- **Short Circuit Current (Isc):** 0.0A
- **Open Circuit Voltage (Voc):** 0.0V

VERTICAL board with TWO WAY ARROW Flashing system through a pushbutton control circuit that allows to display 06 functions.

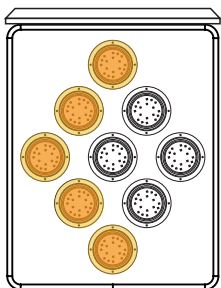

FLASHING  
LEFT CHEVRON

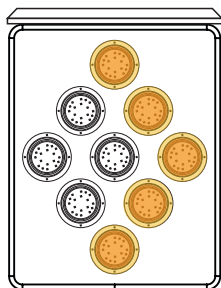

FLASHING  
RIGHT CHEVRON

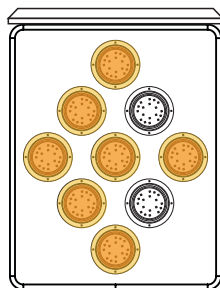

FLASHING  
LEFT ARROW

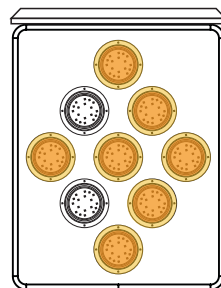

FLASHING  
RIGHT ARROW

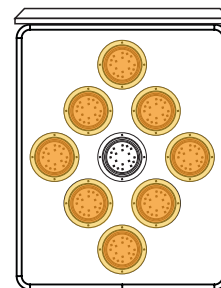

FLASHING  
TWO WAY ARROW

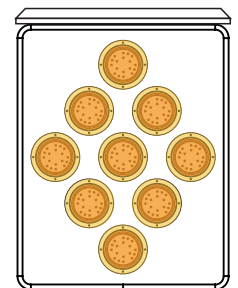

FLASHING  
STOP