

# Solar Nestable Barrier Robust 835

Code: BA-RO/835AN-S

## Great savings in storage & transportation!

### UNITY IS STRENGTH

This barrier is an efficient, safe, and affordable tool, perfect to guarantee effective signage.

*The perfect barrier to be used in places without street light, and or to guide motorists.*

The **solar nestable** barrier is an innovative and convenient solution for road safety.

Designed to delineate and sign.

It also helps to manage traffic, avoiding accidents and guaranteeing the safety of users.

Ideal to block roads, sign works, separate lanes and detours, as well as delineate sports activities and special events.

Their nestable structure facilitates mounting and detachment, adapting to different situations quickly.



### Features

- Barrier with modular system of easy installation, making it more exclusive and highly functional on the market.
- Its intelligent design allows stacking, reducing the 75% in storage and transportation costs, an affordable and convenient option for any signage type.
- It can easily adjust to different lengths according to the specific needs of the project or event.
- Manufactured in white high-density polyethylene with UV protection, providing a long life span, resistant to inclement weather, and temperature changes.
- Body engraved with two chevrons per face to add reflective sheeting (optional), increasing night visibility.
- Fast and safe installation of male-female system; suitable for assembly by one person with minimal effort.
- In addition, it can add stabilizing weight (available in big or small sizes) to improve performance before strong wind gusts.

#### Intelligent Solar Lighting:

- Equipped with ultrabright, latest-generation LEDs, it can incorporate one or two solar cells of high efficiency for excellent light diffusion.
- Batteries recharge for 6 hours and last 16 hours working.
- Includes JVM circuit for high reliability, with the ability to synchronize with multiple barriers for a uniform visual effect.



ENGRAVED CHEVRONS  
IN BODY



HANDLE TO  
MANAGE



SAFE COUPLING



SOLAR CELL

# Solar Nestable Barrier Robust 835

Code: BA-RO/835AN-S

Dimensions and other measures are nominal and may vary by +/- 2%.

Dimensions in: in

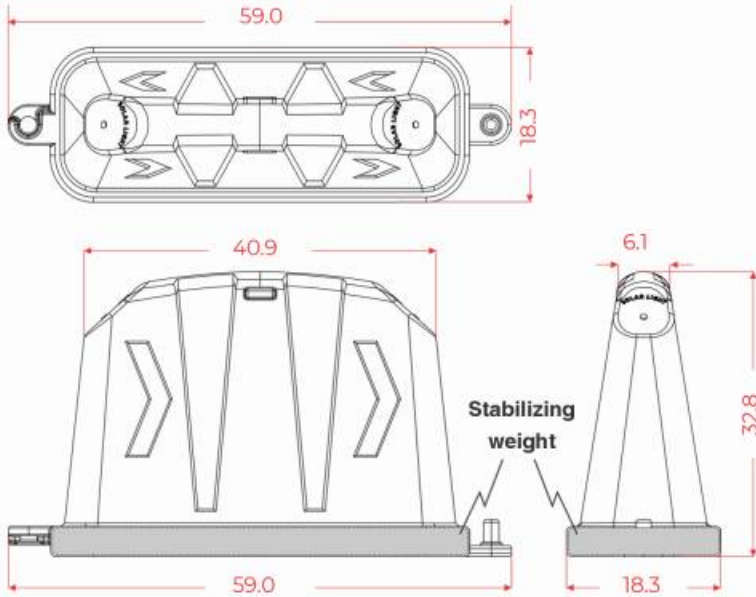







## Measurements

**Total** Total length: 59.0 in  
Width: 18.3 in  
Height: 32.8 in

**Color of Reflector:** White

**Weight of barrier (without base): 15.43 lbs**

	barrier+S base	barrier+S base+1 light	barrier+S base+1 lights
<b>Small base barrier</b>			
	25.794 lbs	26.455 lbs	27.116 lbs
	barrier+L base	barrier+L base+1 light	barrier+L base+2 lights
<b>Large base barrier</b>			
	38.580 lbs	39.242 lbs	39.903 lbs



53-ft dry van with capacity for approximately 1,134 nestable barriers, covering up to 5,580 linear feet of channelization