

A leader doesn't follow steps, he marks the way.

There's no water loss due to evaporation, the vapor condensates inside the third inner container and recovers its original volume.  
Maintenance-free.

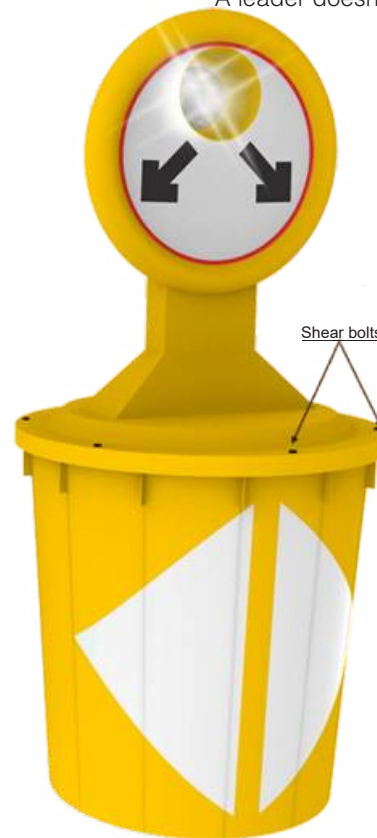
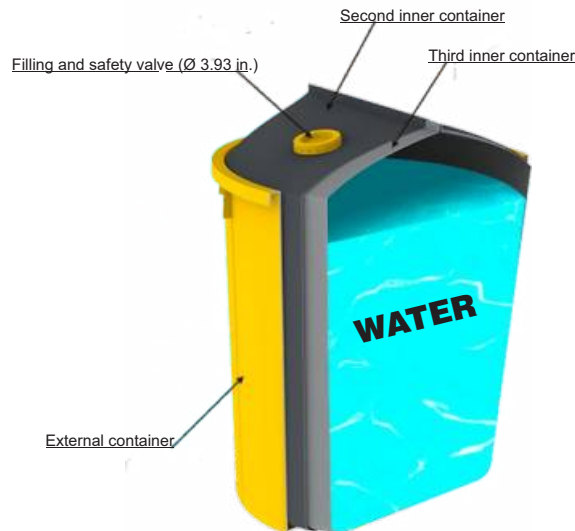

## FEATURES

- The **Triple Container Impact Absorber TCIA** (pat. pend.) is an effective crash cushion developed to save lives and minimize every damage caused by road accidents. It consists of a main module and a group of universal modules.
- It can be mainly used in highway junctions and high-speed railroads to protect bridges, posts and vertical signs.
- Each module consists of an external container with a capacity of 105.68 US gal which inside houses the second flexible container which in turn has inside a third flexible container.
- The inner containers fill up to 80% of their capacity with water leaving a 20% of empty space so it can move inside of the containers when the module gets hit.
- The protection that the external container brings makes a barrier with the inner containers. This prevents that sunlight spreads across avoiding formation of bacteria in the water and by doing so it can be preserved for years without being replaced.
- The inner containers are hermetically sealed thanks to a filling and safety valve. This way, when it's warm outside the water evaporates inside the third inner container without any vapor leaks. When the temperature drops at night, vapor condensates and water recovers its original volume.
- The Absorb 400 external containers have 12 structural anti-deformation reinforcements that increase the containers' resistance.
- The main module has a lamp with 4 flash sequences making it visible from a great distance and it's fueled by solar panels.
- As a complementary element, it's recommended to integrate a group of flexible bollards (Poliflexy® 66 Bollard code: ITO-PF-66) because when they get run over don't damage vehicles but produce a strong audible warning signal.
- The main module has space for labelling the signs with reflective vinyl.
- The external containers' lids are attached with shear bolts that avoid their detachment due to wind or vandalism.
- Based on the available space of each point, it can be integrated a higher quantity of universal modules to reach the Containment Level NC-3 according to the standard NOM-008-SCT2-2013.
- The filling and safety valve has an inner diameter of 3.93 in. (10 cm).

# Absorb 400 TCIA

Triple Container Impact Absorber Technology (pat. pend.)

Code: ABSORB-400

## Main Module

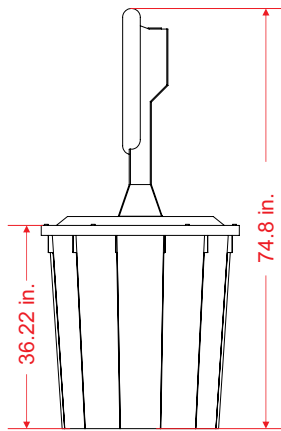
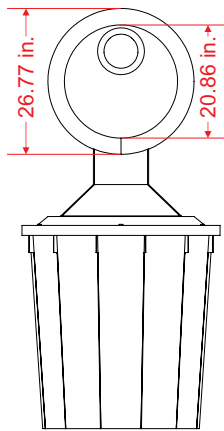
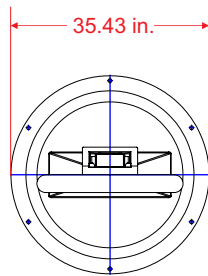

## Measures

### Main Module

**Diameter:** 35.43 in.

**Height:** 74.8 in.

**Capacity:** 105.82 US gal

**Color:** Yellow

### Universal Module

**Diameter:** 35.62 in.

**Height:** 38.18 in.

**Capacity:** 105.82 US gal

**Color:** Yellow

Volumes, dimensions and other measures are nominal and may vary approximately 2 %.

## Universal Module

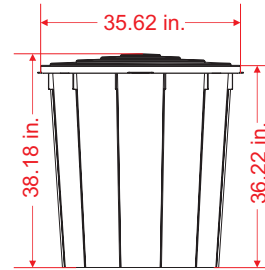

# Absorb 400 TCIA

Triple Container Impact Absorber Technology (pat. pend.)

Code: ABSORB-400

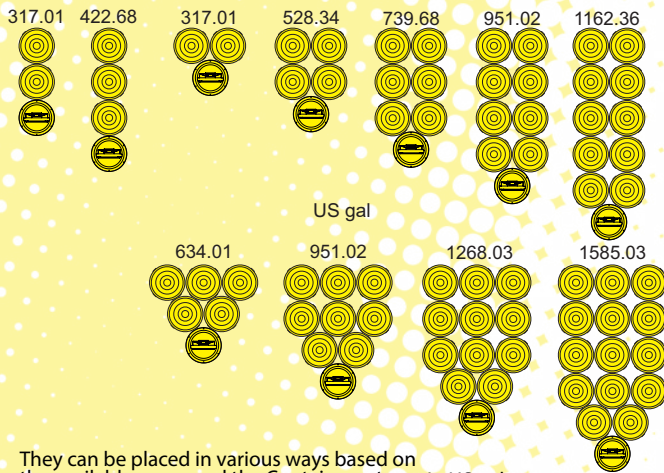

They can be placed in various ways based on the available space and the Containment Level required.

Volumes, dimensions and other measures are nominal and may vary approximately 2 %.

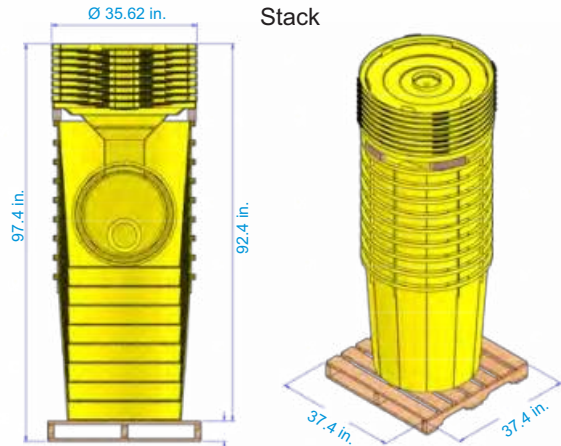

Piling of 1 main module and 8 universal modules (952.38 US gal) on wooden flooring of 37.4 in. x 37.4 in. for transportation in a truck or a container.

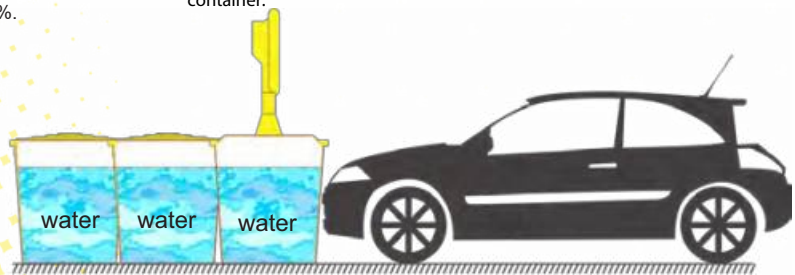

- The **Absorb 400 TCIA with Triple Container Impact Absorber Technology (TCIA)** consist of modules formed by an external container of polyethylene which houses the second flexible container and this in turn has inside a third flexible inner container.
- The third inner container fills up to 80% of their capacity with water and it's hermetically sealed through a filling and safety valve of 3.93 in. which leaves a 20% of empty space so the water has place to move when the module gets hit.



- When a vehicle crashes into the **Absorb 400** system, the external container deforms and gets crushed or breaks putting pressure on the two flexible inner containers.

The water moves and fills the empty space that's on the inner container. This increases the contact surface and absorbs the "moment" of impact of the vehicle. If the external container breaks, the inner containers adapt themselves to the car and embrace it, this makes them continue to absorb the impact force. At the same time, the main module moves in the direction of the collision and pushes the universal modules that are behind, making the same effect of water displacement inside each module. This way, it continues to absorb the force of collision through every module.



•The subsequent modules create a cushioning chain reaction that slows down the vehicle in a controlling and safe manner.

• A higher quantity of modules could be integrated based on the available space and the containment level required on each point.