

# PC-8 SHARPS & BIOHAZARD WASTE CONTAINERS

CODE: PC-8

## DESCRIPTION

Designed for the secure disposal of needles, syringes, blades, and other sharps, this collector minimizes the risk of injuries and contamination. It complies with stringent safety standards for hazardous waste management.

An optimized capacity combined with a compact structure enables efficient use across hospitals, clinics, medical offices, and other healthcare settings.

Manufactured using chlorine-free components and ultra-low heavy-metal content ( $\leq 1$  ppm), it enables cleaner, safer combustion in facilities that rely on controlled incineration.



For added stability, the optional **SUJE-8 Wheeled Basket** for easy transport can be purchased as an accessory



Complies with  
**NOM-087-SEMARNAT-2002  
STANDARD**



Biological  
waste only



Hazardous  
waste only



Sharp object  
protection







Controlled  
incineration



## FEATURES

- Safety lock mechanism to prevent accidental exposure to contents
- Impact-resistant construction that maintains structural integrity during transport and use
- Space-saving, compact design suitable for various work areas
- Transparent or semi-transparent walls to monitor fill levels
- Certified for use in hospitals, clinics, laboratories, and other regulated healthcare settings

## DIMENSIONS

 Length	7 in
 Width	12 in
 Height	12.6 in
 Weight	16.4 oz
 Capacity	2.1 gal

## MATERIAL COMPOSITION

	Chlorine-free
	Total heavy-metal content: $\leq 1$ ppm

## DESIGN & USE

- Engineered for healthcare environments, the **PC-8 Sharps & Biohazard Waste Container** provide secure handling and disposal of needles, syringes, blades, and other sharps. A user-friendly design minimizes direct contact and supports safe operation
- A hermetic lid combined with a reliable locking mechanism ensures proper containment, reducing the risk of spills, exposure, or contamination
- With an optimal capacity and compact footprint, it is suitable for hospitals, clinics, laboratories, and outpatient facilities that routinely manage sharps waste

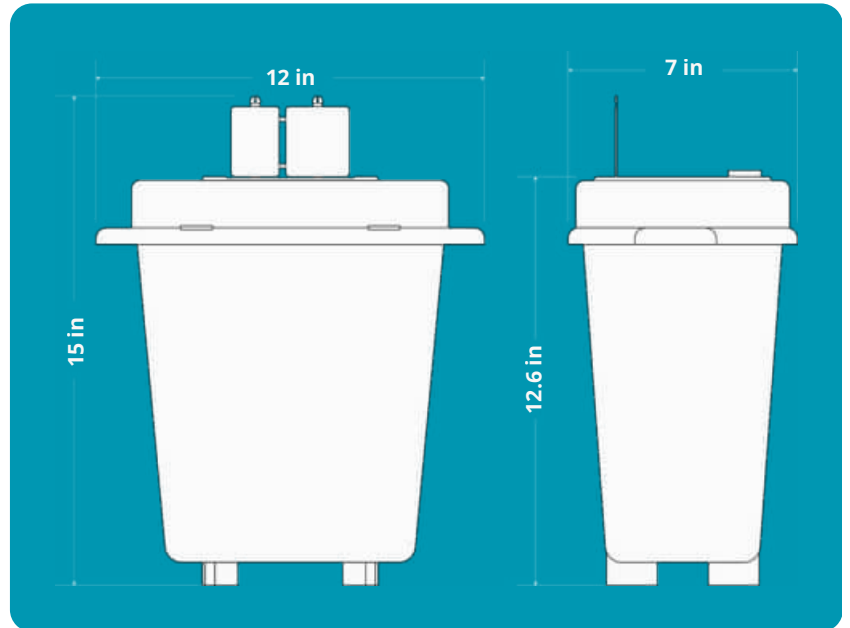

Make hazardous waste collection easier with the

## PC-8 SHARPS & BIOHAZARD WASTE CONTAINERS