



OUTDOOR PICNIC TABLE

CODE: MESA PÍCNIC

DESCRIPTION

The Picnic Table is engineered to deliver a practical and robust solution for outdoor recreational environments. This integrated picnic unit—featuring a table and attached benches—is manufactured from high-strength polymer through rotomolding, delivering superior structural resistance and the ability to withstand impacts without warping.

Perfect for parks, landscaped areas, athletic complexes, educational facilities, rest areas, outdoor cafeterias, and public recreation zones.



FEATURES

- Won't splinter or break and delivers exceptional long-term durability
- Features a uniform finish and smooth surfaces that are easy to clean
- Made from plastic wood sheets
- Water-, pest-, and UV-resistant
- Includes specialized additives that shield the bench from sun radiation
- Engineered for stability in demanding use
- Perfect for families, student groups, and tourists



Weather-change resistant





Manufactured from recyclable and sustainable materials





Resistant to impacts and deformation

TABLE DIMENSIONS

 Length	78.7 in
 Width	23.2 in
 Height	41.7 in

BENCH DIMENSIONS

 Length	78.7 in
 Width	22.8 in
 Height	29.9 in

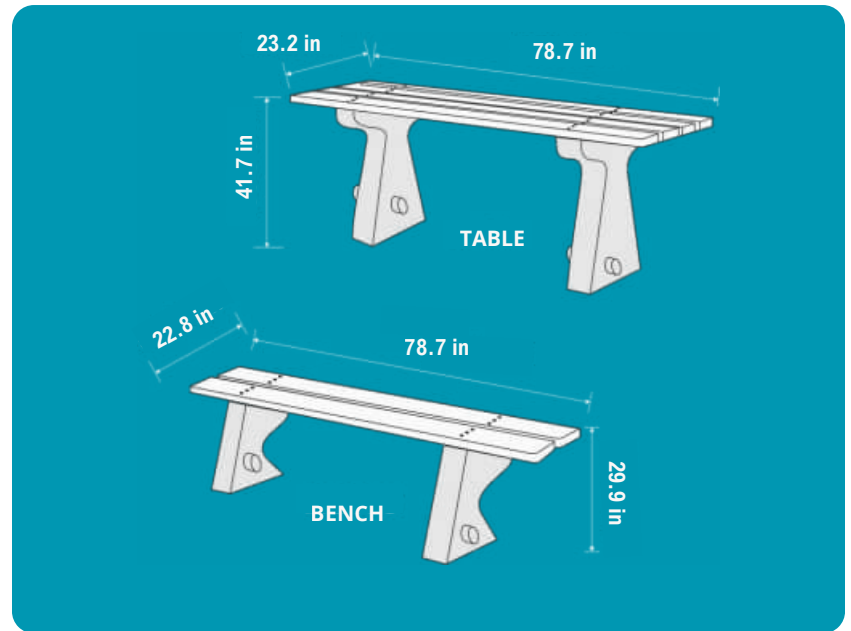

USE & DESIGN

- Suitable for gathering spaces in parks, educational facilities, and recreational venues
- Helps prevent accidental shifting and acts as a deterrent to vandalism
- Enhances user safety, particularly for children and people with limited mobility
- Ensures improved durability in severe weather conditions, including strong winds and flooding
- Easily integrates with other urban furniture components
- Intended to seat up to five users

Comfort and durability
For any setting

**OUTDOOR
PICNIC TABLE**